

# 4G

## SOLAR PTZ CAMERA

### User Manual



V2.1

#### 1:PRODUCTS & PACKING LIST

##### 1.1 Product picture:



##### 1.2 Packing list:

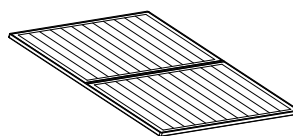

1\* Solar panel

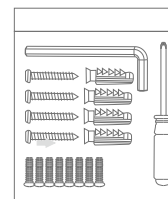

- 1\*Screw kit
- 1\*Hexagon spanner
  - 1\*Screw driver
  - 8\*Screws
  - 4\*Tapping screw

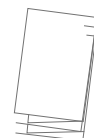

1\*User manual

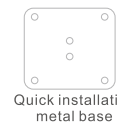

Quick installation metal base



1\* PTZ Camera

- 1\* USB charging cable

#### Product Diagram

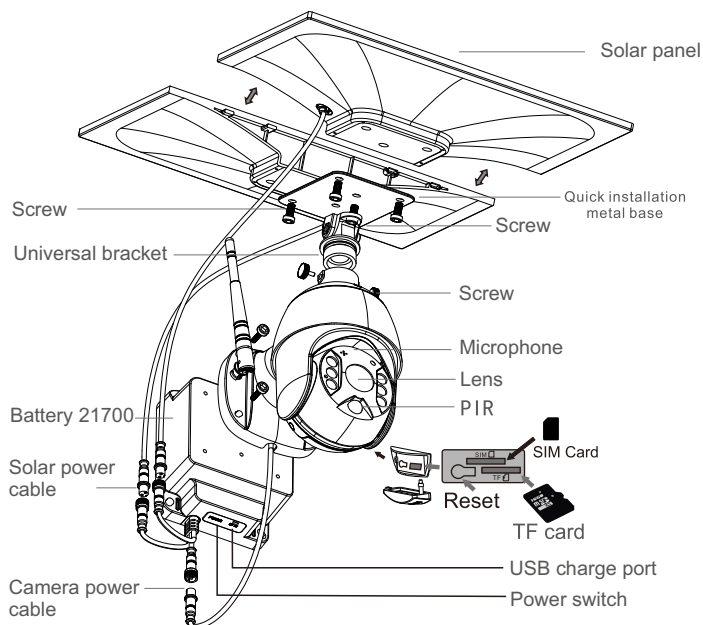

#### 1.3 Installation Process

- 1.3.1 Splice two solar panels together, then fix the iron plates with special screws under the panel, finally install the universal bracket with the right angle
- 1.3.2 Solar panel: Connect panel to camera, and fix it with screws in a suitable angle.
- 1.3.3 TF card and Sim card installation: Open the silicon flap and insert the TF card and Sim card, then make sure to make sure to close the silicon flap to avoid rain leakage.
- 1.3.4 Make sure both camera power cable and panel power cable are connected.

#### 2 .INSTALLATION

##### 2.1 Intergrated installation

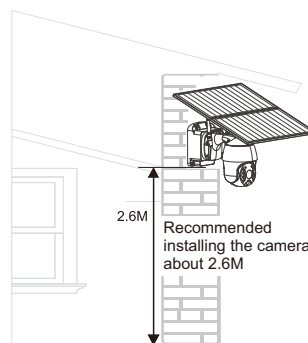

2.6M  
Recommended installing the camera about 2.6M

##### 2.2 Separated installation

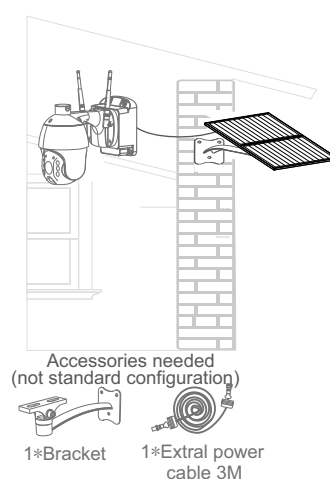

#### 3. APP INSTALLATION

- 3.1. Scan the following QR codes or search for "UBox" from the App Store(for iOS devices) or Google Play Store (for Android smartphones) to download and install the app.



IOS



Android

#### 3.2. APP REGISTRATION

- 3.2. 1.Open the app then input your E-mail address then press 'Register'. Check and select to agree the agreement then your E-mail box will get an verification code.( For better user's experience, please allow to open all permissions to avoid missing any notifications from the app.)
- 3.2. 2. Input the "Verification code" and press 'Next'. (if you not found the mail you might find the code in your email spam box. )

3.2.3. Set the login password and confirm the login password. Then press 'Register' to next step. (For your password safety, the password requires more than 8 characters plus a combination of letters)

3.2.4. Enter your E-mail address, and input your login password. Then press 'Login'.

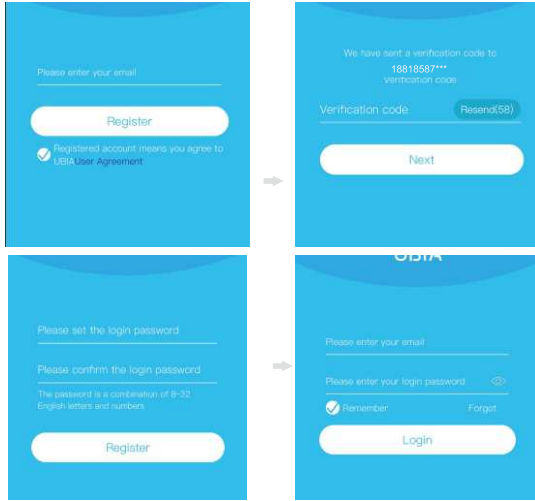

#### 4. WI-FI CONNECTION

- 4.1. Press 'Add Family' then set the room or position as per reminders.
- 4.2. Enter your family name and then press 'Next'.
- 4.3. Input the necessary information just like Country, Province, then press 'Done'.
- 4.4. Press 'Add a device' to add a smart device

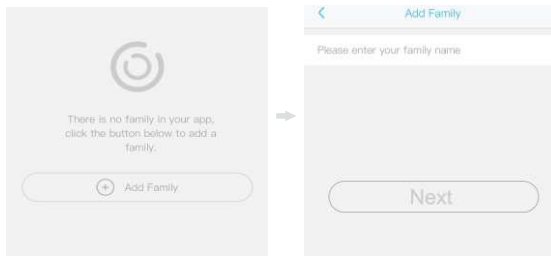

- 4 -

4.11. The device will enter to the device list automatically. Setup success! The device is ready to use.

#### 4.12. Notes about PIR detection

\*User can change the PIR detection sensitivity in device settings. we recommend to set sensitivity at "Disabled" or "Low" to reduce false alert and save the battery power in noisy environments.

\*Disabled: disabled PIR detection.

\*Low: delay 7 seconds PIR detects a moving.

\*Medium: delay 5 seconds PIR detects a moving.

\*High: delay 1 second PIR detects a moving.

#### 5. DEVICE SETTING

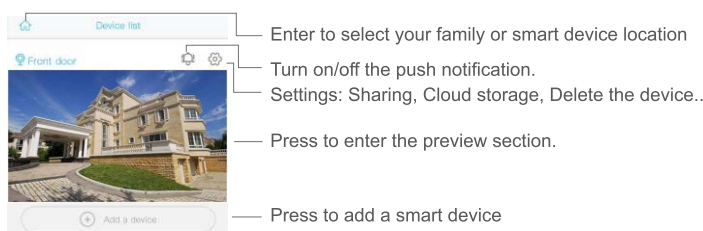

Smart device basic settings  
Could set "Storage management, Flip screen, Environmental model, PIR detection, Sleep time, Power frequency, LED indicator, Device name"  
Could check the information of "Device name, Device ID, Model, FW version, Manufacturer, Check for the FW updates."

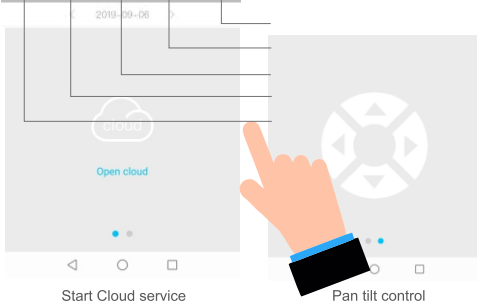

- 6 -

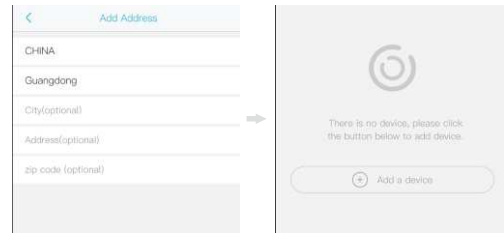

- 4.5. insert the SIM card into device then put the battery into the device, and some of models need install antenna.
- 4.6. After the power on the device, wait for about 1 minute the device blue LED light up Then press next.
- 4.7. If the device blue LED not light up, please check below config notes.
- 4.8. Find the UID QR code on device, then use APP scan the QR code.

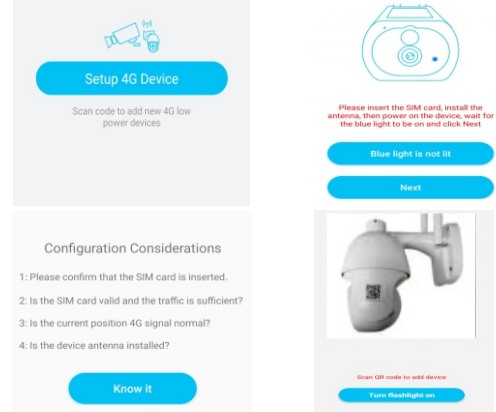

- 4.9. APP search the device in internet it may take 5-60 seconds.
- 4.10. Select the name and device location then press 'Done.'

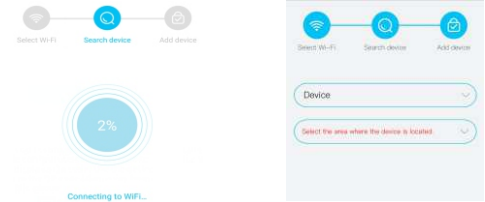

- 5 -



Check "my account" name and change password;

18818587\*\*\*\*

- Cloud Service → Check and purchase the Cloud storage;
- Face recognition → Check and purchase the AI Cloud Facial Recognition;
- My Friends → Check and add my friends list and permission;
- Common Settings → Set the default voice and resolution for the devices;
- About → Press to add a smart device

Click the "Calendar" icon on the right top corner, then choose the date to playback the videos from cloud storage.

Choose the desired date to check all videos from the cloud.

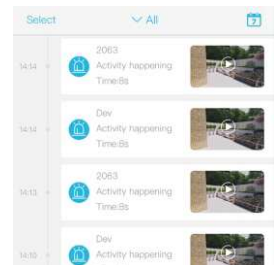
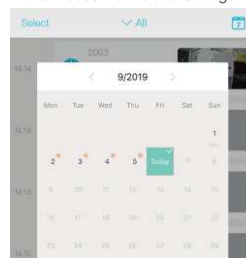

#### 6. SPECIAL NOTES!

- 6.1. The device is equipped with a rechargeable lithium battery. The battery life will be affected by the device wake-up time and the number of wake-ups. Therefore, the PIR sensor alarm detection function is used in an environment with a lot of people. It is recommended to turn off or set the device to low sensitivity to reduce device wake-up and call times extend battery life. When the battery is low, please charge the battery immediately.
- 6.2. Keep the device in range of your router. Make sure the device is placed close to the Wi-Fi router. If there has to be thick or insulated objects between the device and the Wi-Fi router, which may lead to weak Wi-Fi signal, please make sure the Wi-Fi signal is in good level before you start using the device.
- 6.3. It is a delicate device with low power consumption design. Everytime the device is awakened and will work for few seconds. After that, the device will enter standby mode to save power. You can set the work time in the app settings.
- 6.4. Because the mainland China does not receive Google's system push messages, you need to open the app's self-starting function in your phone to receive push messages.
- 6.5. This device provides one month of free cloud storage services. If you need to continue using value-added services after the trial period expires, you need to purchase them in the app.

- 7 -